

15V
4313RN

Ford Ranger Raptor; Md. 2023

EU-Pedestrian Protection Bar 76 mm

EU-Personenschutzbügel 76 mm

Protection avant, homologuée CEE, 76 mm

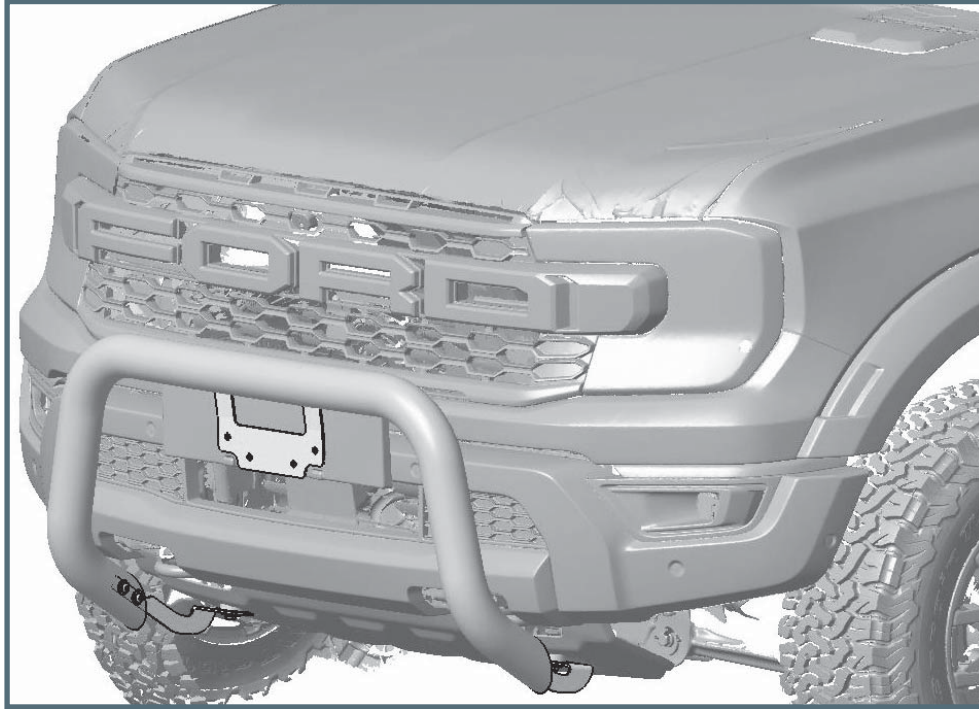

ASSEMBLY INSTRUCTION

Montageanleitung • Instructions de montage

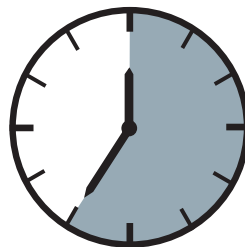

35 Minuten

article no.:

15V4313RN (S) inox

15V5313RN black steel

Revision 1: 15.03.2023



M6:
10 Nm
M8 (A2):
21,4 Nm
M10:
50 Nm

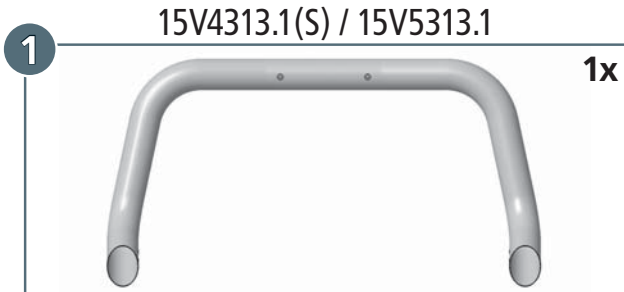
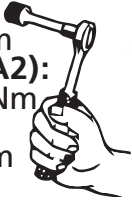

mounting kit: 15V9213RN

	M8x25; DIN 933 A2	2x
	M10x40; DIN 933 Zn	2x
	M8x25; ähnl. ISO 7380 A2	4x
	M6x30; DIN 7991 Zn	4x
	Ø4,8x19; DIN 7981C A2	4x
	Ø5,3; DIN 9021 A2	4x
	Ø8,4; DIN 9021 A2	4x
	SW 13	2x

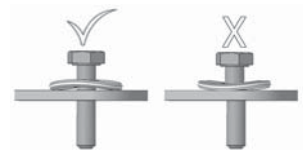
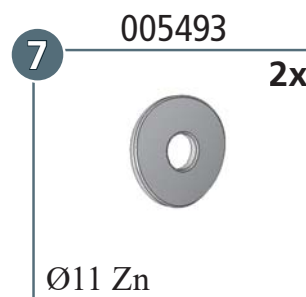
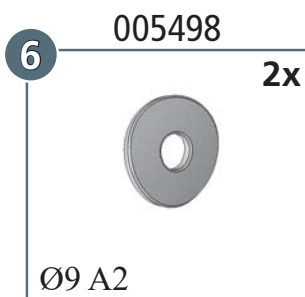
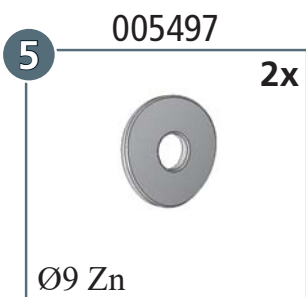
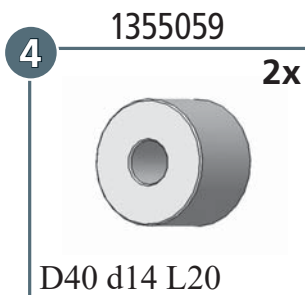
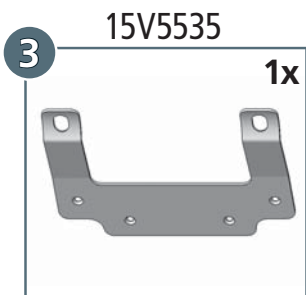
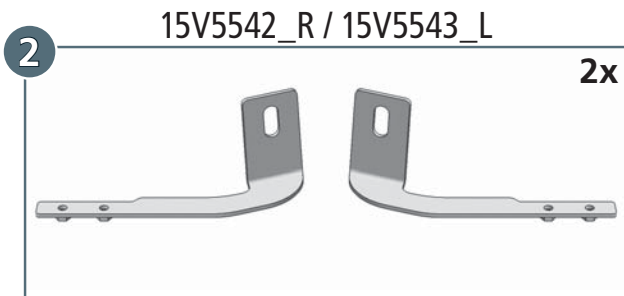

article no.:
15V4313RN (S) inox
15V5313RN black steel

Revision 1: 15.03.2023



